

# Technika

## User Guide

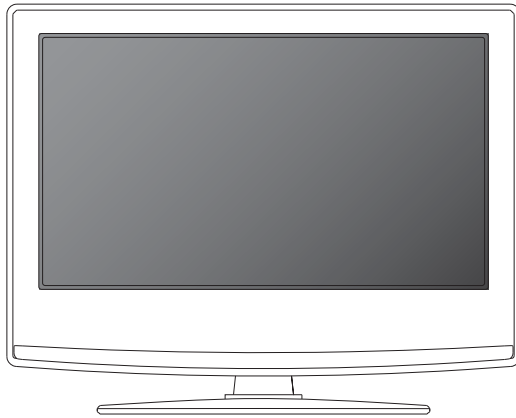

### Model No

28E21B-HDR/DVD

32E21B-FHD

32E21B-FHD/DVD

32E21W-FHD/DVD

39E21B-FHD

# IMPORTANT SAFETY INSTRUCTIONS



Please read these instructions. All the safety and operating instructions should be read before the appliance is operated.

## Warnings

- To reduce the risk of fire, electric shock or damage to the television, do not expose it to dust, rain or moisture, or place any objects filled with liquids on or near the television.
- Do not place the television in a confined space, ensure that nothing can obstruct the ventilation openings at the rear of the television.

To prevent spread of fire, keep candles or other open flames away from this product at all times



- Dispose of this television and any components including batteries in an environmentally friendly manner. If in doubt, please contact your local authority for details of recycling.

## Safety

- For your safety, this appliance is fitted with a fused moulded 3 pin mains plug. Should the fuse need to be replaced, ensure that any replacement is of the same amperage and approved with the BSI mark.
- Never try and replace the mains plug unless you have adequate qualifications and are legally authorised to do so. In the event that a replacement Mains cable is required, contact the manufacturer for a suitable replacement.
- Never use the television if it is damaged in any way.
- Always place the television on a flat level surface avoiding anywhere which may be subject to strong vibration.
- Ensure the television is not placed on top of the power cable as the weight of the television may damage the cable and cause a safety hazard.
- Never place mobile phones, speakers or any other device which may cause magnetic or radio interference with the television. If interference is apparent, move the device causing the interference away from the television.
- To disconnect the apparatus from the mains, please use the switch located on the underside/ rear of the TV. The switch shall remain readily operable.
- When installing on a wall, ensure the TV is at least 5cm from the wall for ventilation

## Maintenance

- To clean this unit, wipe with a soft, dry cloth. If the surfaces are extremely dirty, use a soft cloth dipped in a soap and water solution or a weak detergent solution.
- Never use alcohol, paint thinner or benzene to clean this unit.
- Before using a chemically treated cloth, read the instructions that came with the cloth carefully.

**CAUTION:** If water or other liquid enters the television through the display panel surface, a malfunction may occur.



## Packaging

- The safest way to transport your item is in the original box/packaging - please save your packaging for this.
- You will need original box/packaging in the event of warranty/service repair or support. We are unable to carry out warranty/service if you are unable to package it correctly.

# IMPORTANT SAFETY INSTRUCTIONS



Please read these instructions. All the safety and operating instructions should be read before the appliance is operated.

## Important Information Regarding Use of Video Games, Computers, Captions or Other Fixed Image Displays

The extended use of fixed image program material can cause a permanent "shadow image" on the LCD/LED panel.

This background image is viewable on normal programs in the form of a stationary fixed image. This type of irreversible LCD/LED panel deterioration can be limited by observing the following steps:

1. Reduce the brightness/contrast setting to a minimum viewing level.
2. Do not display the fixed image for extended periods of time.
3. Turn the power off when not in actual use.

Examples of images that you need to watch out for are as follows (this is not an exhaustive list):

- TV Channel Logos: e.g. Shopping channel logos and pricing displays-especially if they are bright and stationary. Moving or low-contrast graphics are less likely to cause ageing of the screen.
- Time Displays
- Teletext: Do not view a stationary page for a long period of time
- TV/DVD Menus: e.g. Listings of DVD disc content
- Pause Mode: Do not leave the TV in pause mode for long periods of time, e.g. When watching DVDs or videos.

**Important** - Once 'shadow image/screen burn' occurs, it will never disappear and is not repairable under warranty.

## How do I dispose of this product?

**UK:** Waste electrical products should not be disposed of with household waste. Separate disposal facilities exist. For your nearest facilities, please see [www.recycle-more.co.uk](http://www.recycle-more.co.uk) or in store for details.

**RO:** Waste electrical products should not be disposed of with household waste. Separate disposal facilities exist. Check with your Local Authority or retailer for recycling advice.

### Batteries

- Do not expose batteries to high temperatures, excessive heat, prolonged sunshine or fire as this may cause leakage, explosion or ignition.
- Observe the correct polarity when inserting batteries.
- Do not use different types of batteries together or mix old and new batteries.
- Dispose of batteries in an environmentally friendly way.
- Certain regions may regulate the disposal of batteries. Please consult your local authority.



## TV Models with built in DVD players

### CAUTION:



This caution label is located on the rear panel of the unit

THIS UNIT IS A CLASS 1 LASER PRODUCT. THIS UNIT USES A VISIBLE LASER BEAM WHICH COULD CAUSE HAZARDOUS RADIATION EXPOSURE IF DIRECTED. BE SURE TO OPERATE THE PLAYER CORRECTLY AS INSTRUCTED. WHEN THIS UNIT IS PLUGGED INTO THE WALL OUTLET, DO NOT PLACE YOUR EYES CLOSE TO THE OPENINGS TO LOOK INTO THE INSIDE OF THIS UNIT.

USE OF CONTROLS OR ADJUSTMENTS OR PERFORMANCE OF PROCEDURES OTHER THAN THOSE SPECIFIED HEREIN MAY RESULT IN HAZARDOUS RADIATION EXPOSURE. DO NOT OPEN COVERS AND DO NOT REPAIR YOURSELF. REFER SERVICING TO QUALIFIED PERSONNEL.

---

# CONTENTS

---

Manufacturers Guarantee Information . . . . .	3
Important Safety Instructions . . . . .	4-5
What is included in the box . . . . .	8
Attaching/Detaching the stand and wall mounting . . . . .	9-11
TV Buttons and Input Source Menu . . . . .	12
Remote Control . . . . .	13
Connections . . . . .	14-15
TV Menu Operation . . . . .	16-21
Channel Menu . . . . .	16
Picture Menu . . . . .	17
Sound Menu . . . . .	18
Time Menu . . . . .	19
Feature Menu . . . . .	20
Setup Menu . . . . .	21
DVD Menu . . . . .	23
7 Day TV Guide . . . . .	24
USB Record - Digital / Freeview . . . . .	25
USB Mode / Media Player . . . . .	26
General Information . . . . .	27-29
Using your TV with a Sky digital set top box . . . . .	27
Frequently Asked Questions . . . . .	28
Technical Specifications . . . . .	29



For DTS patents, see <http://patents.dts.com>. Manufactured under license from DTS Licensing Limited. DTS, the Symbol, & DTS and the Symbol together are registered trademarks, and DTS TruSurround is a trademark of DTS, Inc. © DTS, Inc. All Rights Reserved.

# WHAT IS INCLUDED IN THE BOX

## Accessories

Included with this TV are the following accessories

1 x User Guide

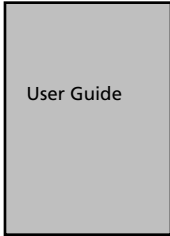

1 x Remote Control



1 x Quick Start Guide



2 x AAA Batteries



1 x TV

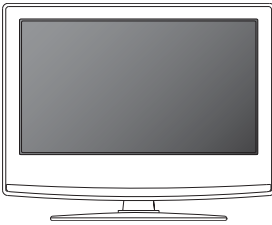

1 x Mini Component / YPbPr



1 x Stand Installation Pack  
(Includes stand base, stand neck & screws)

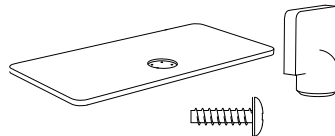

1 x RF Cable



Please save your packaging as you will need this in the event of warranty/service repair or support. We are unable to carry out warranty/service if you are unable to package it correctly. The safest way to package your item in the event of warranty/service repair is in its original box/packaging.

# ATTACHING/DETACHING THE STAND

## Attaching the stand for 28" and 32" models

To complete the stand installation you will require a cross head screw driver

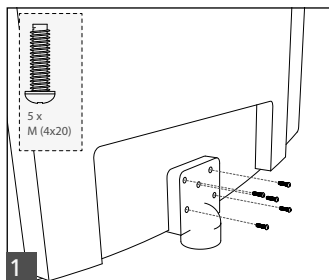

(fig.1) Secure the neck to the TV by using the 5 x M(4x20) screws provided.

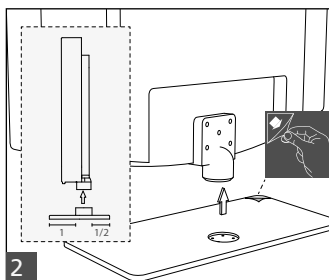

(fig.2) Peel off the protective plastic cover then attach the stand base to the stand neck.

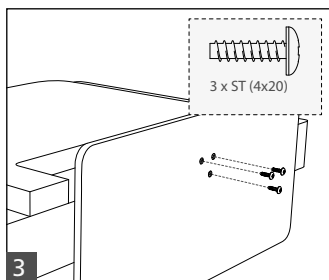

(fig.3) Secure the base to the neck by using the 3 x ST(4x20) screws provided.

## Attaching the stand for 39" models

To complete the stand installation you will require a cross head screw driver

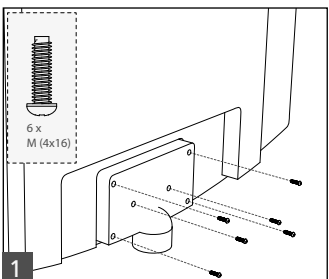

(fig.1) Secure the neck to the TV by using the 6 x M(4x16) screws provided.

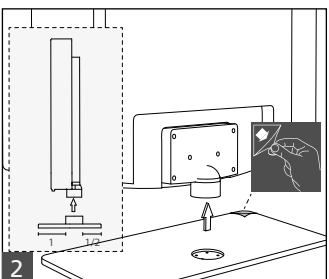

(fig.2) Peel off the protective plastic cover then attach the stand base to the stand neck.

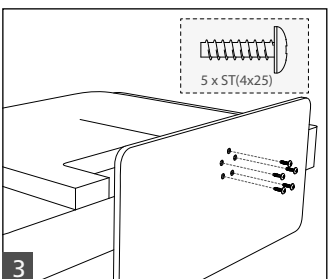

(fig.3) Secure the base to the neck by using the 5 x ST(4x25) screws provided.

# ATTACHING/DETACHING THE STAND

## Detaching the stand

Remove the screws highlighted then remove the stand base and neck from the rear of the TV set.

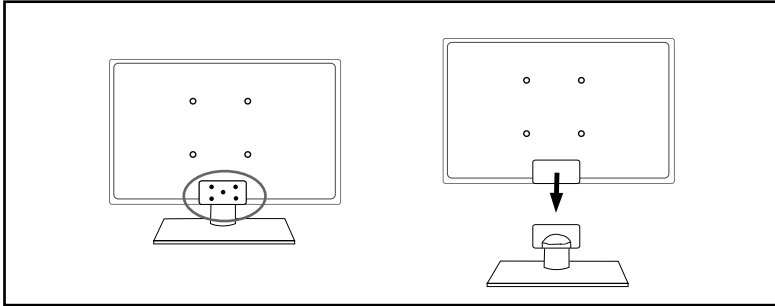

## Wall mounting the TV

**IMPORTANT** - Before drilling any holes in the wall ensure you are not drilling where there could be any electric wires, water or gas pipes.



- 1) Remove the four screws highlighted that are supplied in the wall mounting holes.
- 2) The wall mount can now be easily attached to the mounting holes on the rear of the TV.

**Important** – If wall mounting this TV, only use the screws already provided in the wall mounting holes. Using other screws which are longer could cause irreparable damage to internal parts.

For optimum viewing, if wall mounting the TV higher than eye level, the TV should be tilted downwards so that the TV's screen is 'face on'. See fig 1 and 2

fig 1 INCORRECT

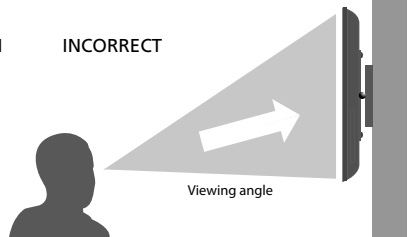
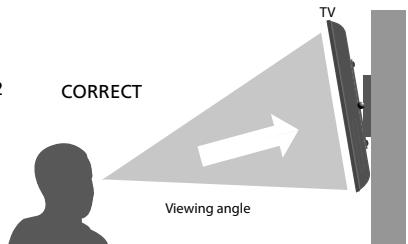
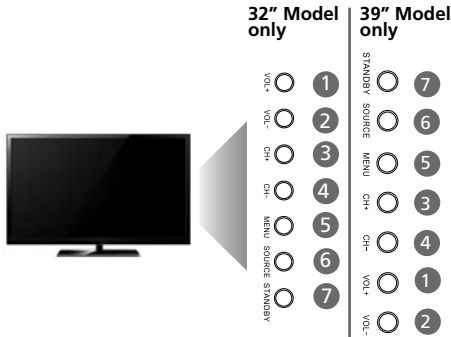

fig 2 CORRECT



# TV BUTTONS & SOURCE MENU

This information is for models  
without built in DVD players



- 1 Volume up and menu right
- 2 Volume down and menu left
- 3 Programme/Channel up and menu up
- 4 Programme/Channel down and menu down
- 5 Displays Menu/OSD
- 6 Displays the input source menu
- 7 Standby Power On/Off

This information is for models  
with built in DVD players

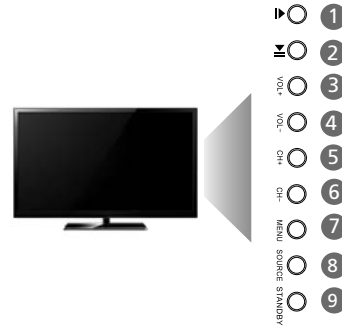

- 1 Stop/Eject Disc
- 2 Play/Pause Disc
- 3 Volume up and menu right
- 4 Volume down and menu left
- 5 Programme/Channel up and menu up
- 6 Programme/Channel down and menu down
- 7 Displays Menu/OSD
- 8 Displays the input source menu
- 9 Standby Power On/Off

## Choosing Mode Input/Source

To switch between the different input/connections.

A) Using the buttons on the remote control:

- 1) Press [SOURCE] - The source menu will appear
- 2) Press [V] or [Λ] to select the input you require.
- 3) Press [OK]

B) Using the buttons on the Television:

- 1) Press [SOURCE]
- 2) Scroll up / down using CH+ / CH- buttons to the input/source you require
- 3) Press Vol+ to change input/source to the one selected.



Example of Source menu depending on the TV model







# REMOTE CONTROL

- 1 STANDBY - Switch on TV when in standby or vice versa  
 MUTE - Mute the sound or vice versa  
 DTV - Switch to Freeview source  
 RADIO - Switch to radio whilst in Freeview source  
 USB - Switch to USB source  
 DVD - Switch to DVD source

- 2 NUMBER BUTTONS - 0 – 9 to select a TV channel directly.  
 TV GUIDE - Opens the 7 Day TV Guide (Freeview mode)  
 ↶ - To return to the previous channel viewed

- 3 VOL (+/-) - To increase / decrease the sound level  
 P.MODE - Scrolls through picture mode options  
 S.MODE - Scrolls through sound mode options  
 FAV - To display favourites menu  
 CH (+/-) - To increase or decrease the channel being watched  
 MENU - To display OSD menu  
 EXIT - To exit all menus  
 (▲/▼/◀/▶/OK) - Allows you to navigate the on-screen menus and adjust the system settings to your preference  
 SOURCE - To display the input/source menu  
 INFO - Press once for now/next channel information  
 Press twice for programme information about current programme

- 4 ASPECT - To switch the screen between the different picture formats  
 SLEEP - Press repeatedly to cycle through the sleep options  
 AUDIO - To change the audio language (if available)  
 SUBTITLE - To switch the dialogue at the bottom of the screen (on/off)  
 TEXT - To enter/exit Teletext (Analogue TV)  
 TEXT HOLD - Teletext mode - Hold current page which is displayed (Analogue TV)  
 DISPLAY - To switch off the screen when listening to radio  
 TEXT/DVD ZOOM - Zoom function for Teletext and DVD  
 DVD MENU/RECORD - Access the DVD root menu and USB record function
  - ⏪ - To restart the current chapter
  - ⏩ - To advance forward to the next chapter
  - ⏹ - To stop the playback/Eject Disc  
 (To EJECT the disc press/hold the  button for 4 seconds)
  - ⏮ - To play in fast rewind mode
  - ⏭ - To play in fast forward mode
  - ⏸ - To play/pause
- ▶ DVD SETUP/REC LIST - Opens up DVD Menu or Opens the list of what has been previously recorded
- ⏮ GOTO - To go to a specific chapter
- ⏮ A-B - Press once to set point, press a second time to return to point
- ◌ ANGLE - Select different angle of DVD
- ⏮ 3D - Change to 3D mode
- ⏮ REPEAT - To repeat playback

-  For Models with Integrated DVD players
-  For Models with PVR Function
-  For Models with USB Playback
-  For Models with 3D Feature



# CONNECTIONS

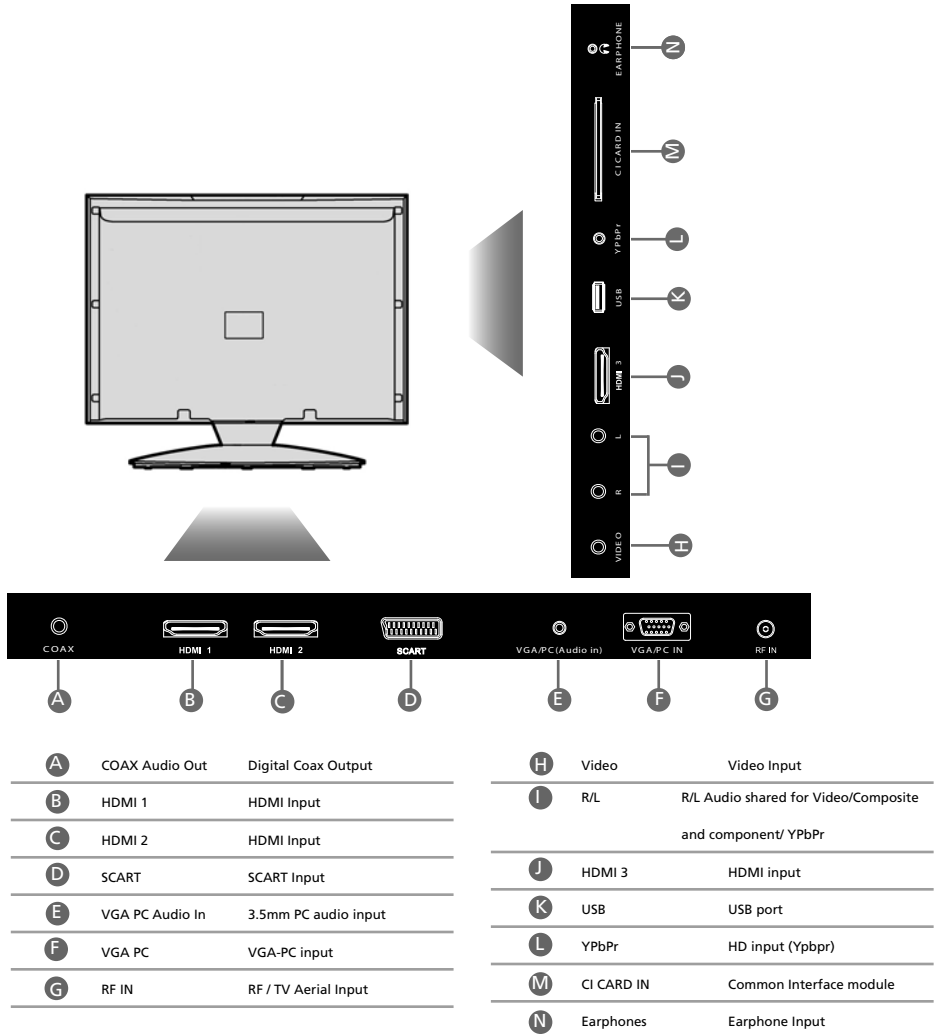

Connecting to a device with video Composite AV/Video output  
TV Source should be set to Video

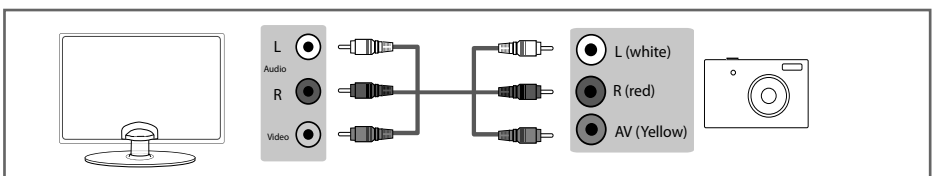

# CONNECTIONS

## Connecting to a device with SCART output

TV Source should be set to SCART



## Connecting to a device with HDMI output

A HDMI cable can output both video and audio and enables you to enjoy digital-quality video and audio with minimal loss of quality.

TV Source should be set to the corresponding HDMI port (HDMI 1, HDMI 2 etc)

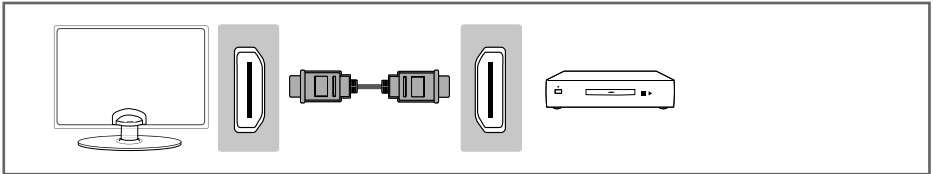

## Connecting to a device with Component/YPbPr output

If you are supplied with a cable from the device which has RED, GREEN, BLUE, RED & WHITE connectors you must connect via Component (for picture) and by phono cable (for sound).

TV Source should be set to Component.

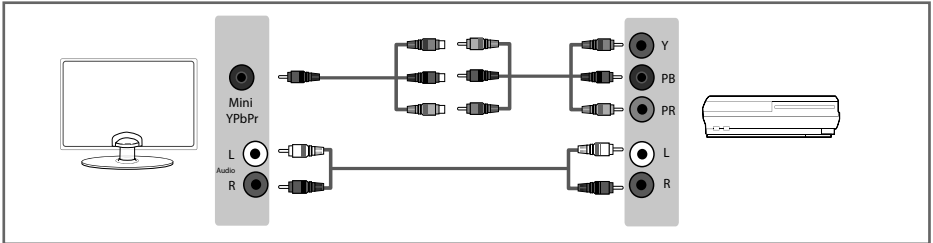

## Connecting to a device with VGA (Laptop or Desktop Computer)

TV Source should be set to VGA/PC

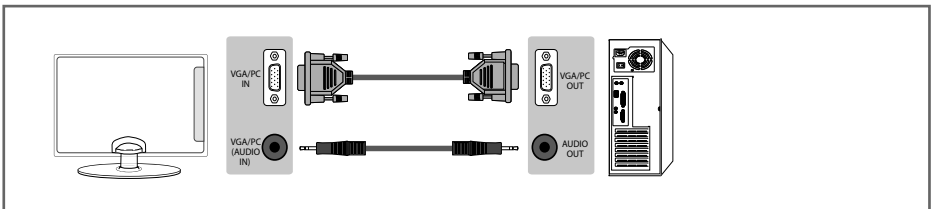

# CHANNEL MENU



To access this menu, press [MENU] button on the remote control.  
To enter a menu press [OK]

If you wish to make changes to any of the default settings, use the scroll ▲▼▶◀ buttons.  
To confirm any settings press [OK] button. To exit this menu at anytime, press [EXIT] button.

Auto Tuning - Allows you to retune the television for all digital channels, digital radio stations and analogue channels

Freewiew Manual Tuning- Allows you to manually tune your digital signal

Analogue Manual Tuning - Allows you to manually tune your analogue signal

Programme Edit - Allows you to delete, skip and add favourite channels



Signal Information - Allows you to view signal frequency, signal quality and signal strength

**Tip:** If you do not press any buttons for 30 seconds, the menu will automatically exit. You can change the length of time before the menu exits automatically - see 'Menu Duration' in the Setup Menu

# PICTURE MENU

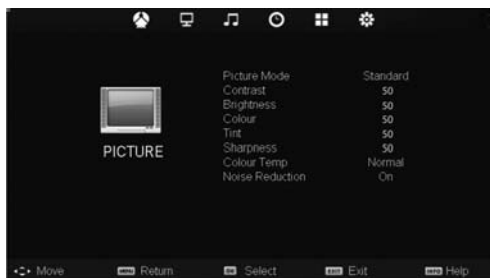

To access this menu, press [MENU] button on the remote control and scroll right.  
To enter a menu press [OK]

If you wish to make changes to any of the default settings, use the scroll ▲▼▶◀ buttons.  
To confirm any settings press [OK] button. To exit this menu at anytime, press [EXIT] button.

**Picture Mode** - Choose from the following presets:

Ecohome	Power saving mode which reduces the energy used by up to 25% (by reducing the power to the LED/LCD panel). In Ecohome mode, the TV will switch itself to Standby mode after 3-5 hours in the event that the TV buttons or remote control buttons are not pressed (change the picture mode to another setting to de-activate this function)
Standard	Standard settings
Dynamic	Recommended settings for fast moving pictures
Mild	Set to be lighter in colour and less bright
Personal	Lets you manually alter all the settings

You can make the following adjustments in **Personal** mode:

**Contrast** - Switch the balance between black and white.

**Brightness** - Increase or decrease the brightness of the picture.

**Colour** - Increases the colour from black and white.

**Tint** - Lets you increase or decrease the level of tint within the picture (only available in VGA/PC source mode).

**Sharpness** - Increase or decrease the sharpness of the picture.

**Colour Temperature** Choose from the following presets:

Normal	Default settings
Warm	Increases red within the picture
Cold	Increases blue within the picture

**Noise Reduction** - Choose from the following presets:

Off	Turns noise reduction off
Low	Minor system adjustment
Middle	Medium system adjustments
High	Maximum system adjustments
Default	Default settings

# SOUND MENU



To access this menu, press [MENU] button on the remote control and scroll right.  
To enter a menu press [OK]

If you wish to make changes to any of the default settings, use the scroll ▲▼▶◀ buttons.  
To confirm any settings press [OK] button. To exit this menu at anytime, press [EXIT] button.

Sound Mode - Choose from the following presets

Standard	Default settings
Music	Emphasises music over voices
Movie	Provides live and full sound for movies
Sports	Emphasises sound for sports
Personal	Selects your personal sound settings

**Tip:** Treble and bass levels can only be adjusted when the sound mode 'Personal' is selected.

Treble - To adjust the amount of high frequency within the sound

Bass - To adjust the amount of low frequency within the sound

Balance - To switch the sound between the left and right speakers

Auto Volume Level (AVL) - When 'on' is selected, the volume will attempt to stay at a constant level regardless of TV programme and advertisements

Surround Sound- Choose from the following options:

Off	Turns the surround sound off
TruSurround HD™	This TV is equipped with TruSurround HD to give improved sound quality and richness . The default setting is set to 'TruSurround HD' as on.

Digital Output - This is the digital COAX Audio output. Choose from the following options:

Off	To turn off Digital Output
Auto	Selects the best settings automatically
PCM	Select this option if you are connecting to a Stereo Hi-fi via coax cable (Pulse-code modulation (PCM) is a digital representation of an analogue signal)

AD Volume - Increase or decrease the Audio Description volume



For DTS patents, see <http://patents.dts.com>. Manufactured under license from DTS Licensing Limited. DTS, the Symbol, & DTS and the Symbol together are registered trademarks, and DTS TruSurround is a trademark of DTS, Inc. © DTS, Inc. All Rights Reserved.

# TIME MENU



To access this menu, press [MENU] button on the remote control and scroll right.  
To enter a menu press [OK]

If you wish to make changes to any of the default settings, use the scroll ▲▼▶◀ buttons.  
To confirm any settings press [OK] button. To exit this menu at anytime, press [EXIT] button.

---

Clock - Shows the date and time

Off Time - Allows you to set a specific time for your TV to turn off

On Time - Allows you to set a specific time for your TV to turn on, the channel it will then display, the source it will be on and also the volume. This function can then be toggled to repeat every day or a certain day (the TV must be in standby mode for this to be effective)

Time Zone - Change your current time zone

Sleep Timer - Lets you set the sleep timer so the television automatically switches off after a set amount of time. Off -> 10min -> 20min -> 30min -> 60min -> 90min -> 120min -> 180min -> 240min

Auto standby - Set Auto standby between 3 hours, 4 hours and 5 hours ( to turn off this function you must exit eco home mode in the Picture Menu)

# FEATURE MENU



To access this menu, press [MENU] button on the remote control and scroll right.  
To enter a menu press [OK]

If you wish to make changes to any of the default settings, use the scroll ▲▼▶◀ buttons.  
To confirm any settings press [OK] button. To exit this menu at anytime, press [EXIT] button.

Schedule List - Lists your programme reminders

PVR File System - Allows you to view format and performance of a connected USB key

CI Information - Pay per view services require a "smartcard" to be inserted into the TV

If you subscribe to a pay per view service the provider will issue you with a 'CAM' and a "smartcard". The CAM can then be inserted into the COMMON INTERFACE PORT (CI Card In)

System Lock - Allows you to lock or unlock the menu. You will be asked to enter a 4 digit password.

Use the ◀ button to quit the password input or use the ▶ button to clear. Default password is 0000.

Once the system lock menu has been accessed you can choose from the following options

System Lock	Turns the System lock on/off
Key Lock	Turns the Key lock on/off
Parental Guidance	Turns Parental Guidance on/off
Default Source	Select the Source the TV will be set to when the TV is switched on
Default Channel	Select the Channel the TV will be set to when the TV is switched on
Source Lock	Turns the Source lock on/off
Channel Lock	Turns the Channel lock on/off
Max Volume	Controls the maximum volume of the TV sound system
Change Password	Changes the password to access the system lock options

Audio Language - Shows the current audio language

Subtitle Language - Shows the current subtitle language



# SETUP MENU

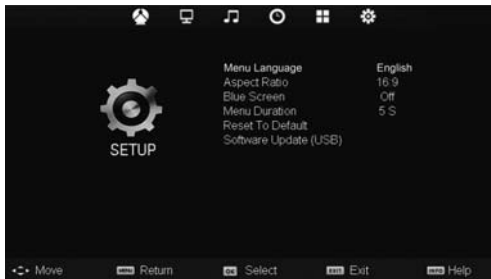

To access this menu, press [MENU] button on the remote control and scroll right.  
To enter a menu press [OK]

If you wish to make changes to any of the default settings, use the scroll ▲▼▶◀ buttons.  
To confirm any settings press [OK] button. To exit this menu at anytime, press [EXIT] button.

## Menu Language - Allows you to change the language of the menu

**Aspect Ratio** - Within the UK the picture format varies depending on the channel/broadcast. There are a number of different options to best meet your needs

### Auto

Automatically displays the best picture format. So the picture is in the correct position. May have black lines at the top/bottom and/or sides.

### Original

Will display the picture from the broadcaster without any change

### Zoom

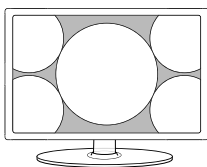

The picture is the correct proportion but zoomed in to fill the screen

### Stretch

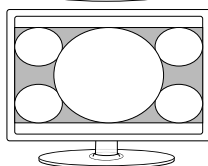

Displays the 14:9 picture in the correct proportion. As a result side bars are shown on the screen

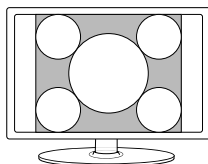

Displays the 4:3 picture in its original size. Side bars are shown to fill the 16:9 screen

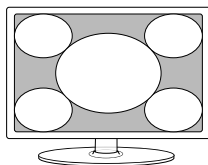

### 16:9

Fills the screen with a regular 16:9 signal and 4:3 picture format will be stretched to fill the screen

**Blue Screen** - Changes the background when there is no input between clear and a blue background (Only available on some sources)

**Menu Duration** - Lets you adjust the amount of time the On Screen Menu stays on the screen before disappearing

Reset to default

Reset Menu System - This resets the menus to factory settings.

Reset TV Channels - This clears all the TV channels from the television.

**Software Update (USB)** - From time to time we may release new firmware to improve the operation of the television (available to download). This menu lets you install the new software/firmware onto the television. Further details of how to do this will be issued with the firmware. Contact the helpline or refer to the 'product support' section of the website

# DVD SETUP

(Applies to models with built in DVD player)



To enter this menu please ensure the TV is in DVD source & press [DVD SETUP]

If you wish to make changes to any of the default settings, use the scroll **▲▼▶◀** buttons. To confirm any settings press [OK] button.

To exit this menu at anytime, press [DVD SETUP] button.

TV Display - Choose from the following options

4:3 Pan scan	PS Traditional picture format, often used on old film
4:3 Letter box	LB Traditional picture which has been adapted for widescreen
Wide	16:9 Widescreen picture format

Speaker Setup - Choose from the following options

LT/RT	Converts from multi-channel sound to mono
Stereo	Converts from multi-channel sound to stereo

Dual Mono - Choose from the following options

Stereo	Outputs 2 channels of sound both left and right
Mono L	Outputs left side sound
Mono R	Outputs right side sound
Mix Mono	Outputs a single channel of sound but mix between right and left

Dynamic Range - This is the difference between the quietest and loudest sounds. This setting works only with DVD discs recorded in Dolby digital.

Full	Set this to listen with the range recorded on the disc
3/4	Set this to listen with a range equivalent to a normal television
1/2	Set this to listen with a smaller difference between the maximum and minimum volume
1/4	Set this to listen with a smaller difference between the maximum and minimum volume
Off	Set dynamic range to off

Tip: This TV/DVD player is pre-set to play Region 2 DVDs. In the event you wish to use the TV/DVD in another country that uses different region discs, please visit [www.umc-uk.co.uk](http://www.umc-uk.co.uk). Select 'Product Support', 'Changing Region'.

# 7 DAY TV GUIDE

TV Guide is available in Digital TV mode. It provides information about forthcoming programmes (where supported by the freeview channel). You can view the start and end time of all programmes and on all channels for the next 7 days and set reminders.

1) Press [TV GUIDE]. The following 7 Day TV Guide will appear.

7 Day TV GUIDE		
10 Years Younger: The Challenge		
Season 2		
Support worker Janice Cassidy's lifestyle of long working hours and a penchant for tanning has taken its toll, while the stress of bringing up two daughters and heavy smoking has affected interior designer Shere Morady. Surgeon Jan Stanek and the team set out to provide		
04 Aug 2010 10:42		
BBC1	05:00-06:00	10 Years Younger: The Challenge
BBC2	06:00-06:30	The Simpsons
ITV1	06:30-07:00	Hollyoaks
Channel 4	07:00-08:00	Channel 4 News
five	08:00-09:00	How to Look Good Naked
BBC3	09:00-10:00	Newlyweds: The One Year Itch
BBC4	10:00-11:15	Big Brother
ITV2	11:15-11:45	The Big Bang Theory
Record	Remind	Prev Day
Move View	Display	Next Day
		EXIT Exit

2) Navigate through the menu using ▲▼▶◀

You can now:

Record a programme by pressing RED (USB device must be connected)

Set a reminder by pressing GREEN

View a previous day by pressing YELLOW

View the next day by pressing BLUE

3) Press [EXIT] to exit the 7 day TV Guide.

# USB RECORD - DIGITAL/FREEVIEW MODE

## USB RECORD – DIGITAL/FREEVIEW MODE

Built into this television is a USB record facility. This function is available in Digital/Freeview mode when used in conjunction with a compatible USB memory stick or USB Hard drive. The benefits of this are as follows:

- Pause live TV and then playback, fast forward and rewind (up to live TV)
- One button record, if you decide you want to record the current programme
- Easy programmable recording from the 7 day TV Guide
- Record TV and watch/listen back on your computer/laptop

Due to the nature of the product, it is necessary to use a high speed USB memory stick (as the TV reads from and writes to the memory stick at the same time, some memory sticks may not be suitable)

You can purchase high speed memory sticks from some computer stores, alternatively, we have a selection of tested and compatible memory sticks available to purchase directly from the helpline/web site.

### Minimum Specification - USB Memory Stick

Read Speed	20 MB/s (Mega Byte Per Second)
Write Speed	6 MB/s (Mega Byte Per Second)

**If you wish to use a USB portable hard drive larger than 32GB, please refer to the FAQ section at the rear of this user guide.**

## Pause Live TV (Time Shift)

Pausing Live TV is very simple.



- ▶ - Press the play/pause button and the television will pause and the live content will be recorded. To resume watching press play/pause again.
- ▶▶ - Press fast forward to go forward in a recording (i.e. to skip adverts)
- ◀◀ - Press fast rewind to go back in a recording (i.e. if you fast forwarded too far)

**Tip:** When you switch the TV to standby or change channel the Time Shift memory is wiped. To restart time shift you must press play/pause button.

## One Button Record

At any point in time you may decide to record the current channel that you are watching. To do this you need to press the red button highlighted below.



**Tip:** This television contains one TV tuner, therefore it can only record the channel you are watching or record one channel while the television is in standby mode.

**Note:** USB record function is only available in Digital/Freeview TV mode. Due to copyright laws and illegal copying/recording it is not possible to record to/from any other input/output source.

# USB MODE / MEDIA PLAYER

USB mode offers playback of various different types of content that you have saved on your USB Memory Stick.

On switching to USB source the above menu screen will appear. The content will be divided into Photo, Music, Movie and Text based on file type.

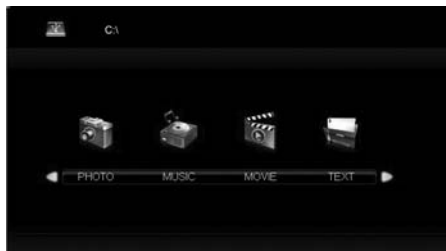

1) You can navigate through the menus using the scroll ▲▼▶◀ buttons. To confirm the item you wish to play/view press [OK] button.



2) Select the drive you require. (If your drive only has 1 partition you will only see 1 item).



3) You can now access the item. Press OK to view.



4) While viewing you control the item using or by pressing (i) and using ▲▼▶◀ and (OK)



**Tip:** If you experience a playback issue, please ensure the files being used are the correct format (example - the picture plays but no sound) See technical specification page for compatible file types

## USING YOUR TV WITH A SKY DIGITAL SET TOP BOX

### Option 1) Connecting your TV to your Sky box (when both the TV and Sky Box are located in the same room)

Depending on your Sky Box & TV model, connect either by SCART or HDMI cables (available separately)

If connecting by SCART, select the 'Input source' on the TV as SCART.

If connecting by HDMI, select the 'Input source' on the TV as HDMI (if the TV has more than 1 HDMI port, ensure you select the input source to match the HDMI numbered port on the rear of the TV)

If you wish to use your Sky remote to operate the TV's functions, you will need a Sky remote control (Revision 9 or later) and you will need to programme a 4 digit code into it. See bottom of this page.

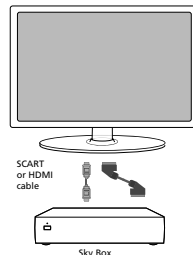

### Option 2) Connecting your TV to your Sky box (when your Sky box is located in a different room to the TV)

Please note, if you are adding a 'Magic Eye/TV Link' to your system so that you can use your Sky remote control to change the Sky channel in the room where the 2nd TV is located, please refer to the instructions included with the TV link/magic eye in order to ensure the RF or RF2 output on your Sky box is powered on. (The red LED light on the TV link/magic eye will light up if the RF / RF2 output is correctly set up) If you do not have the instructions that came with the TV link/magic eye, instructions on how to do it can be found on our web site.

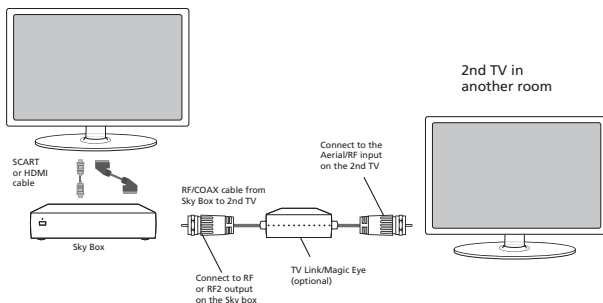

- 1) To tune the TV to the Sky box, on the 2nd TV, select the 'Analogue' input source.
- 2) Select the channel that you wish to store the Sky box/channel on. (If you do not use channels 1-5 because you no longer have analogue terrestrial channels after digital switchover, you may choose to select channel 1 to store the Sky box/channel, if you still have and use analogue channels 1-5, you may for example decide that channel 6 is the best option for you)
- 3) Press the corresponding number on the remote control to select the desired analogue channel chosen as per point 2 above.
- 4) On the TV remote control, press Menu. Now navigate through the menus to select Manual Tuning or Analogue Manual tuning (refer to the Tuning/Channel menu section of this user guide if necessary)
- 5) Manually tune in the channel (usually, the Sky box is at a frequency between 800Mhz and 850Mhz) once the Sky box/channel is found, press 'OK' to store it.

If you wish to use your Sky remote to operate the TV's functions, you will need a Sky remote control (Revision 9 or later) and you will need to programme a 4 digit code into it. See below.

#### Using a Sky Remote or a Universal Remote to operate your TV

**Sky Remote Control** - If you wish to use your Sky remote to operate the basic functions of your TV, you need to programme a 4 digit code into it. Please note - you will need the latest Sky Revision 9 remote control as this is the only version that includes the latest software/firmware necessary to operate this model of TV.

**The code required for this television is 2134.** If you wish to upgrade/replace your existing Sky remote control to the latest version, you can do so on our web site.

**Universal Remote Control** - If you wish to use a Universal remote control to operate your TV, please refer to the website for a full list of codes. (Please note we only have codes for One for All branded remote controls, if you have an alternative brand of Universal remote, please refer to the manufacturer for the code.)

# FREQUENTLY ASKED QUESTIONS

General	I would like to have louder sound by connecting additional speakers	1) Use the 3.5mm headphone output and a 3.5mm to phono cable (available separately) to connect to an amplifier/surround sound system. Please note this will deactivate the TV's built in speakers. 2) Connect a COAX cable from the TV's COAX output to your amplifier/surround systems COAX input.
General	Why are some options in the menu unavailable and greyed out	Some options are only available in certain sources, i.e. HDMI. They are unavailable in the other sources where they have no affect.
General	Can I stop my TV automatically turning off after 4hrs?	Yes 1) In the picture settings menu, de-select Eco-home. 2) In the time settings menu, scroll down to Auto standby and select OFF.
TV	I have tuned in Digital TV but I am not receiving any or all of the channels and/or the channels I receive are breaking up	1) Check you are in an area that can receive Freeview. Visit <a href="http://www.freeview.co.uk">www.freeview.co.uk</a> 2) Check you are using an aerial that is able to receive a good digital signal. In most cases, you will need an outdoor digital hi-gain/wideband aerial. In areas that have excellent digital coverage, you may be able to use a loft type aerial but it is highly likely that you will also need to connect a booster between the back of the TV and the TV aerial wall socket. Unfortunately, to receive a good enough digital signal, it is not possible to use a portable/indoor type aerial.
TV	I have re-tuned my television but when I switch it off it is not storing the channels	Complete a first time installation, please refer to the set-up menu section of the manual of how to do this.
VCR/DVD Recorder	I have connected the TV to my VCR or DVD Recorder via SCART but it is not recording	In addition to connecting via SCART, you should connect the aerial cable from the wall socket to your VCR/DVD Recorder and another aerial cable from the VCR/DVD Recorder to the TV.
DVD	I have inserted a disc but it is not playing	1) Ensure you have inserted the disc facing the correct way. 2) Ensure the disc is clean and is not scratched. 3) Some copied discs will not play. 4) Check the DVD is a region 2 disc – to change the region of the DVD player, refer to <a href="http://www.ums-uk.co.uk">www.ums-uk.co.uk</a> select 'product support', 'changing region'.
DVD	I have pressed the eject button but the disc is not coming out	To eject the disc hold the stop/eject button for 4 seconds.
Game Consoles	I have connected my PS3 to the TV via HDMI, but I am not receiving any pictures or sound on my Television	1) Ensure the TV's source is on HDMI. 2) Check your settings on your PS3 are as per the PS3 instruction manual.
Game Consoles	I have connected my Xbox 360 to the TV via Component Cables (Red, Green & Blue) but I am not receiving any sound	Component cables only provide HD Pictures. For the sound you will need to connect the Red & White audio cables on the Xbox to the Red & White phono inputs on the rear of the TV. Please refer to the 'Connections' pages.
USB Mode	I have inserted a USB Memory Key, but the TV does not recognise it	Ensure the USB Memory Key is formatted to type FAT32.
USB Mode	Using a USB portable hard drive / larger than 32GB	If you wish to use a portable hard drive larger than 32GB, please note that it must be formatted to the FAT32 file system in order to operate on this TV. Windows XP/Vista computers are only capable of formatting up to 32GB, therefore, you will need a software programme/utility to format larger hard drives. Please refer to the web site for more information.
System Lock	I have changed the password on the television and now forgotten it	There is a master password of 4711, to gain access to the TV menu and reset the normal password.

# TECHNICAL SPECIFICATION

Model	28" model with inbuilt DVD player	32" Model	32" models with inbuilt DVD player	39" Model
		28E21B-HDR/DVD	32E21B-FHD	32E21B-FHD/DVD 32E21W-FHD/DVD
Screen size (diagonal)	28"/71cm	32"/81cm		39"/99cm
Resolution	1366 x 768	1920 x 1080		1920 x 1080
RF	75 ohm Antenna / PAL-SECAM			
Inputs	3 x HDMI, 1 x USB, 1 x SCART, 1 x Composite/Video, 1 x VGA/PC Input, 1 x VGA/PC Audio in, 1 x Mini Component / Y Pb Pr, 1 x Audio In for Composite / Video and Component / Y Pb Pr			
Sound Outputs	1 x 3.5mm Headphone/Audio out, 1 x COAX out			
Sound power, watts (RMS)	2 x 8			2 x 10
Voltage and power consumption	110 - 240V ~50/60Hz 24/40/70W (ecomode/standard/ max) /<0,5W inStandBy	110 - 240V ~50/60Hz 35/55/80W (ecomode/standard/ max) /<0,5W inStandBy	110 - 240V ~ 50/60Hz 35/55/90W (ecomode/standard/ max) /<0,5W inStandBy	110 - 240V ~ 50/60Hz 45/60/80W (ecomode/standard/ max) /<0,5W inStandBy
Dimensions including stand (mm)	650W x 447H x 161D	739W x 493H x165D		891W x 595H x 210D
Net weight (Kgs)	6.7	8.4	8.8	12.5
Wall Mounting	VESA 100 x 100	VESA 200 x 100		VESA 400 x 400

## Compatible files in USB Mode

Media	File Ext.	Codec			
		Video	Audio		
Movie	.mpg	Mpeg-1, Mpeg-2	MP3, WMA	Max Resolution: 1920x1080 Max Data rate: 40Mbps	
	.avi	Xvid, MJPEG,			
	.ts	Mpeg-2		Max Resolution: 1920x1080 Max Data rate: 40Mbps	
	.dat	Mpeg-1			
	.mp4	Mpeg-1, Mpeg-2			
Music	.vob	Mpeg-2	MP3, WMA	Max Resolution: 1024x768 Max Data rate: 40Mbps	
	.mp3	-			MP3
	.wma	-			WMA
Picture	.jpg	Progressive JPEG		Max Resolution: 1024x768	
	.jpeg	Baseline JPEG		Max Resolution: 8192x8192	
	.bmp	BMP		Max Resolution: 6500x6500	



